

ACCESSORIES

COLLET BUSHES

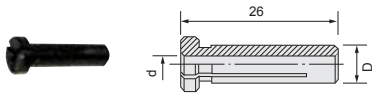

Part N°	Size				Models
	D		d		
	mm	in	mm	in	
G-032347-00	6.0	-	3.0	-	FG-26H, 26HX, 26L, 26HL, 50, 50L, 50Y Series
G-032347-02	6.0	-	-	1/8	FG-3H, 3HL, 4H, 4HL Series
G-032347-03	-	1/4	-	1/8	FA-2C-2, 2BF, 3, 3BF, 2CX-2, 2BF, 3, 3BF

*These collet bushes are used for collet chucks.

COLLET CHUCKS

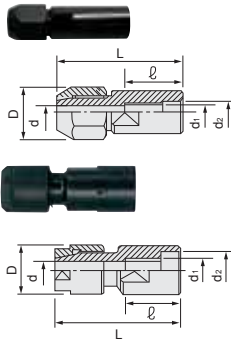

AC N°	Collet	Collet nut	Size							Models		
			d		d ₁	d ₂		D	L		ℓ	
			mm	in			mm	in	mm	mm	mm	
CN-1210	G-101342-00	G-162343-00	6	-	3/8-24UNF	-	3/8	17Hex	57	32	FG-50L-2, 2BF, 50Y-2, 2BF, 3HL-2, 2F, FG-4HL-2, 2F, 3H-5, 5F	
CN-1207	G-041342-00		-	1/4	-	-	-	-	-	-	-	
CN-1402	G-017342-00		6	-	W3/8-16	-	3/8	17Hex	57	32	FG-50L-1, 1BF, 50Y-1, 1BF, 3HL-1, 1F, 4HL-1, 1F, 4H-1, 1F, FG-3VX-1F, 2F, 3F, 6F, 3H-1, 1F, 2, 2F, 6, 4VA-1, 50DX-5F	
CN-1404	G-017342-01		-	1/4	-	-	-	-	-	-	-	
CN-1202	G-011342-00		6	-	3/8-24UNF	-	3/8	17Hex	42	17	FG-2VX-1F, FA-2C-2, 2BF, 2CX-2, 2BF	
CN-1208	G-028342-00		-	1/4	-	-	-	-	-	-	-	
CN-1406	A-122342-01		6	-	W3/8-16	-	3/8	17Hex	42	17	FA-2C-30, 30BF, 2CX-30, 30BF	
CN-1407	A-122342-02		-	1/4	-	-	-	-	-	-	-	
CN-1114	G-144342-03		G-144343-02	3	-	5/16-24UNF	12	-	14	44	21	FG-26H, 26HX, 26L, 26HL, FG-50, 50X Series
CN-1115	G-144342-04		G-144343-02	-	1/8				16	44	21	
CN-1112	G-144342-00	G-144343-00	6	-	-				-	-		
CN-1113	G-144342-01	G-144343-00	-	1/4	-				-	-		

COLLET

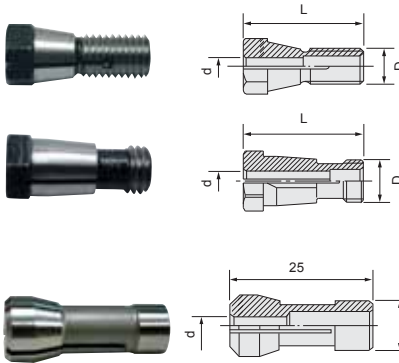

Part N°	d		D	Taper	L	Models
	mm	in				
G-001342-01	3.0	-	1/4-28UNF	3/10	20	TURBO-100
G-001342-02	-	1/8	-	-	-	-
G-002342-00	6.0	-	W11-24	2/5	23	TURBO-100A
G-002342-01	-	1/4	-	-	-	-
G-185342-00	3.0	-	1/4-28UNF	-	18	FG-06-1
G-185342-01	-	1/8	-	-	-	FG-13Series, 13XSeries

Part N°	Size d		Models
	mm	in	
G-028342-08	3.0	-	FG-12U, 12UX
G-028342-04	-	1/8	FG-25D, 25DX
G-028342-07	6.0	-	FG-50D, 50DX
G-028342-06	-	1/4	-

CONE WHEEL

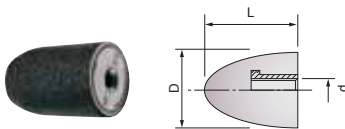

AC N°	Size			Material
	D	L	d	
	mm	mm		
124	38	65	W3/8-16	A-36P

ADAPTER FOR CONE WHEEL

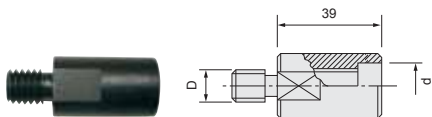

Part N°	Size	
	D	d
	mm	mm
G-158309-00	W3/8-16	5/16-24UNF

SPACER FOR CONE WHEEL

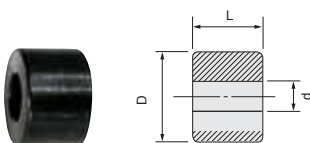

Part N°	Size		
	d	D	L
	mm	mm	mm
G-013308-00	9.53	3/8	20

CONE WHEEL APPLICATIONS



ABRASIVE TOOLS

ACCESSORIES

TUNGSTEN CARBIDE BURRS

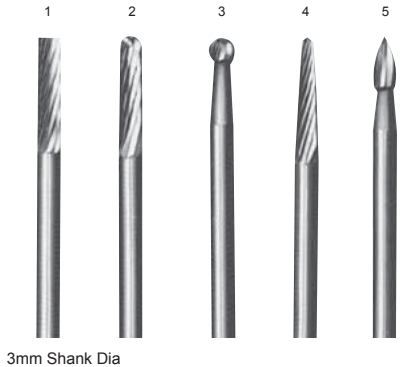

3mm Shank Dia

Index N°	AC N°	Size		Model
		Head Dia mm	Length in	
1	A03	3	38	FG-06-1 TURBO-100 FG-13-1F, 2 FG-13X-1F, 2
2	B03	3	38	
3	C03	3	38	
4	E03	3	38	
5	F03	3	38	

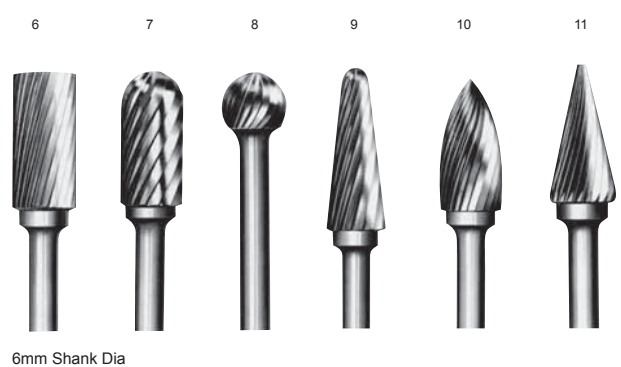

6mm Shank Dia

Index N°	AC N°	Size		Model
		Head Dia mm	Length in	
6	A08(A13)	8(13)	55(70)	TURBO-100A FG-12U, 25D, 50D Series FG-12UX, 25DX Series FG-50DX Series (except FG-50DX-5F)
7	B08(B13)	8(13)	55(75)	
8	C08(C13)	8(13)	55(60)	
9	E08(E13)	8(13)	55(84)	
10	F08(F13)	8(13)	55(75)	
11	H08(H13)	8(13)	55(70)	

MOUNTED WHEEL

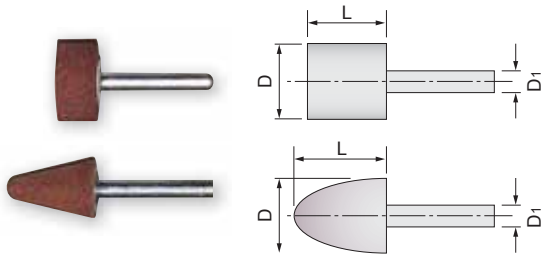

Type	AC N°	Size			Material	Model
		D mm	L mm	D1 mm		
Straight	103	10	10	3	WA-60	FG-13, 13X Series FG-12U, 12UX Series FG-25, 25DX, 50D, 50DX Series FG-12U, 12UX, 26H, 26L, 26HX, 50H, 50HX Series
	105	25	13	6		
Cone	111	10	16	3	WA-60	FG-13, 13X Series FG-12U, 12UX Series FG-25, 25DX, 50D, 50DX Series FG-12U, 12UX, 26H, 26L, 26HX, 50H, 50HX Series FG-25D, 25DX, 50D, 50DX Series, 3H-5, 5F FG-3VX-6F, FA-2C-2, 30, 2CX-2, 30 Series
	113	19	25	6		

*Minimum order required : 100pcs. per item.

SHANK BRUSH

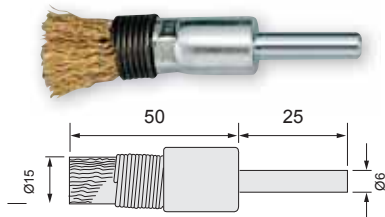

AC N°	Free Speed		Model
	min ⁻¹		
170	15,000		FG-3VX-6F, 3H-5, 5F FA-2C-2, 2BF, 30, 30BF FA2CX-2, 2BF, 30, 30BF

RADIAL WIRE BRUSHES

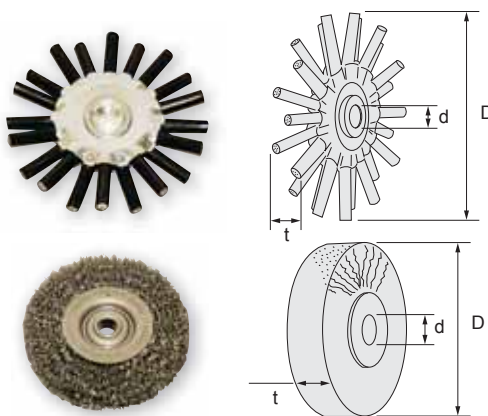

AC N°	Size			Maximum Free Speed min ⁻¹	Model
	D mm	t mm	d mm		
KWH-100WK5	100	13	10	12,000	FG-4H-1, 1F FG-5H-2, FA-150K-2,3, 150KG-7 FG-6H-1, 1M
KWH-123WK5	125	14	16	9,500	
KWH-156WK5	150	17	16	7,500	

*Minimum order required : 10pcs. / item.

AC N°	Size			Maximum Free Speed min ⁻¹	Model
	D mm	t mm	d mm		
181	50	13	10	18,000	FG-50L, 50Y
182	65	13	10	15,000	FG-3H-1, 1F, 3HL-1, 1F
183	75	13	10	13,000	FG-3H-2, 2F, 4HL-1, 1F
184	100	13	10	9,500	FG-4H-1, 1F
184-2	100	13	13	9,500	FG-4H-2, 2F, 5HL-2, 2M
185	125	19	16	7,600	FG-5H-2, 2M
185-2	125	19	13	7,600	FG-5H-1, 1M
186	150	25	16	6,300	FG-6H-1, 1M
187	205	25	16	4,600	FG-8H-1, 1C, 1M

*Minimum order required : 10pcs. / item.

ACCESSORIES

STRAIGHT GRINDING WHEELS FOR STRAIGHT AND EXTENSION GRINDERS

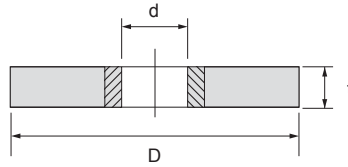

AC N°	Size						Material	Maximum Free Speed min ⁻¹	Models
	D		t		d				
	mm	in	mm	in	mm	in			
•131	50	2	13	1/2	9.53	3/8	A-36Q	18,000	FG-50L, -50Y Series
•132	65	2 1/2	13	1/2	9.53	3/8	A-30R	14,000	FG-3H-1, 1F, 3HL-1, 1F, 2, 2F
•133	75	3	13	1/2	9.53	3/8	A-24P	12,000	FG-3H-2, 2F, 4HL-1, 1F, 2, 2F
•133-1	75	3	19	3/4	9.53	3/8	A-24P	12,000	FG-4HL-1, 1F, 2, 2F
•134	100	4	19	3/4	9.53	3/8	A-24P	9,000	FG-4H-1, 1F
•136-2	125	5	19	3/4	12.70	1/2	A-24P	7,600	FG-5H-1, 1M
•137	125	5	19	3/4	15.88	5/8	A-24P	7,600	FG-5H-2, 2M
•138	150	6	25	1	15.88	5/8	A-24P	6,300	FG-6H-1, 1M
•139	180	7	25	1	15.88	5/8	A-24P	5,300	FG-8H-2 Series
•140	205	8	25	1	15.88	5/8	A-24P	4,600	FG-8H-1 Series

* = Minimum order required : 100pcs. / item, others = Minimum order required : 50pcs. / item.

HEAT SHRINK-TUBES FOR EXTENSION GRINDERS



Comfort grip to soften application vibration and warm to touch.
 Tube diameter will shrink to half size when heated to 120°C.
 Cut to suitable size to fit the tool.

AC N°	Length	Before	After		Object Size	Models
		Inside Dia.	Inside Dia.	Thickness		
	m	mm	mm	mm	mm	
M20-10-1	5	20	10	1	12-17	FG-06
M20-10-2	5	20	10	2	12-17	
M30-15-1	5	30	15	1	18-27	FG-26L
M30-15-2	5	30	15	2	18-27	
M40-20-1	5	40	20	1	23-35	FG-50, 3HL
M40-20-2	5	40	20	2	23-35	
M50-25-2	5	50	25	2	28-45	FG-4HL
M50-25-3	5	50	25	3	28-45	
M60-30-2	5	60	30	2	35-55	FG-5HL
M60-30-3	5	60	30	3	35-55	

ACCESSORIES FOR FA-2C, -2CX SERIES

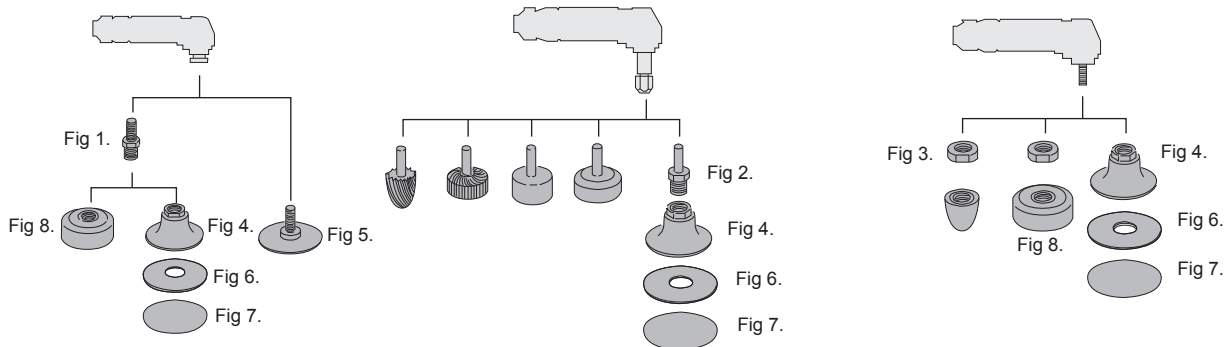

ATTACHMENTS

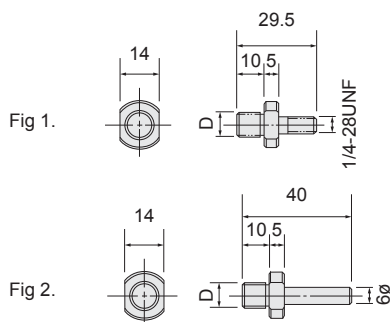

Parts N°	Size	Models
	D	
A-122693-01	W3/8-16	FA-2CX-1, 1BF

Parts N°	Size	Models
	D	
A-122693-03	W3/8-16	FA-2CX-2, FA-2CX-30

ABRASIVE TOOLS

ACCESSORIES

SPACER

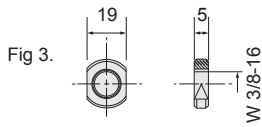

Part N°	Models
A-122308-01	FA-2C-30, 30BF, 2CX-30, 30BF

RUBBER BACKING PADS FIG 4.

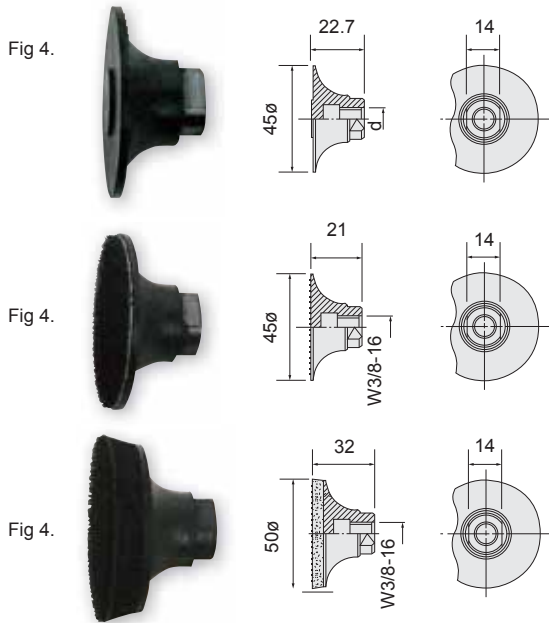

ADHESIVE TYPE

AC N°	Size
	d
RP-2-2	W3/8-16

VELCRO TYPE

AC N°
MP-2-1

VELCRO WITH SPONGE TYPE

AC N°
MP-2-1S

SANDING DISC

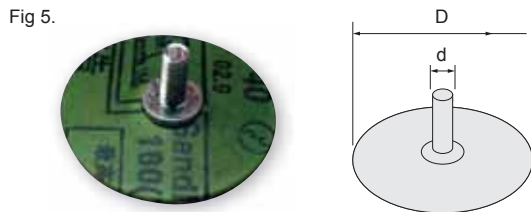

SHAFT TYPE

AC N°	Size		Grit #	Models
	D	d		
	mm	mm		
MD-1	50	1/4-28 UNF	40	FA-2C-1, 1BF FA-2CX-1, 1BF
MD-2			60	
MD-3			80	
MD-4			100	
MD-5			120	

*Minimum order required : 50pcs. / item.



ADHESIVE TYPE

AC N°	Size		Grit #	Models
	D	d		
	mm	mm		
DP-2-1	50	16	40	FA-2C-2, 30 FA-2CX-2, 30 Series
DP-2-2			60	
DP-2-3			80	
DP-2-4			100	
DP-2-5			120	
DP-2-6			150	
DP-2-7			240	
DP-2-8			320	
DP-2-9			180	
DP-2-10			400	

*Minimum order required : 100pcs. per item.

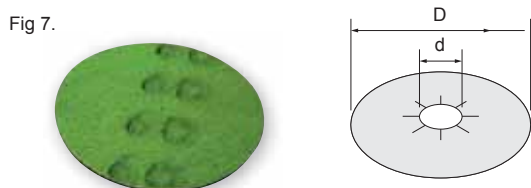

VELCRO TYPE

AC N°	Size	Grit #	Models
	D		
	mm		
MP-2-10	50	40	FA-2C-2, 30 FA-2CX-2, 30 Series
MP-2-2		60	
MP-2-3		80	
MP-2-4		100	
MP-2-5		120	
MP-2-6		150	
MP-2-7		240	
MP-2-8		320	

*Minimum order required : 100pcs. per item.

ACCESSORIES

SPACER

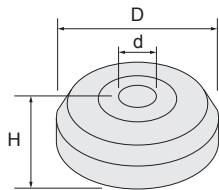

AC N°	Size			Grit #	Models
	D mm	H mm	d mm		
MC-2-16	40	18	W3/8-16	60	FA-2C-2, 2BF, 2CX-30, 30BF

*Minimum order required : 10pcs. / item

RUBBER PAD AND WIRE BRUSH COMBINATION FOR ANGLE SANDERS

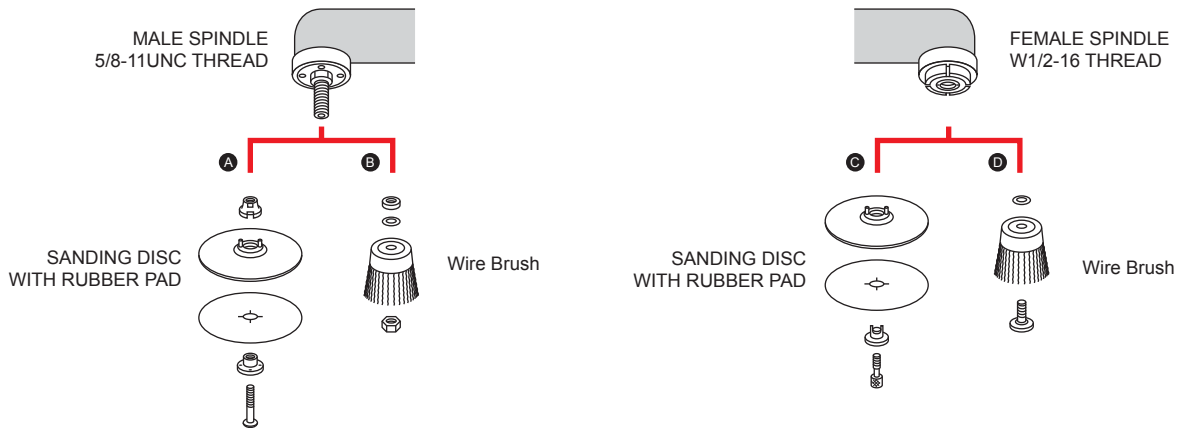

*Male Spindle 3/8-24UNF Thread type is applicable to A type **A**

RUBBER BACKING PADS FOR ANGLE AND VERTICAL SANDERS

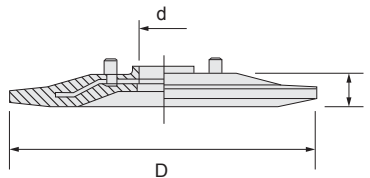

AC N°	Size						Pin Space		Maximum Free Speed min ⁻¹	Models
	D		t		d		mm	in		
	mm	in	mm	in	mm	in				
RP-2-2	45	1 49/64	22.7	57/64	-	W3/8-16	"		15,000	FA-2C-1, 1BF, 2CX-1, 1BF *(A-122693-01) FA-2C-2, 2CX-2, 2C-30, 2CX-30 Series *(A-122693-03)
RP-3-2	75	3	10.5	13/32	15.8	5/8			13,500	FA-3CK-1
RP-5-3	125	5	17.0	43/64	22.2	7/8	44	1 47/64	8,500	FA-150K-2, 3
RP-5-5	125	5	17.0	43/64	22.2	7/8	46	1 13/16	8,500	FA-5C-5, 150KG-7, 5E-7 Series
RP-5-6	125	5	14.0	35/64	22.2	7/8	46	1 13/16	8,500	FA-5E-4 Series
RP-7	180	7	15.0	19/32	22.2	7/8	46	1 13/16	7,000	FA-150KG-7, 5C-5, 6C-9, 10, FA-5E-6 Series, 5E-7V, 7E-1, 5 Series, FV-7-1M, 2M
RP-9-1	230	9	15.0	19/32	22.2	7/8	46	1 13/16	5,900	FA-9C-2, 2M, 4, 4M, FV-9BH-1M

DISC BACKING PADS FOR FG-5PX-1

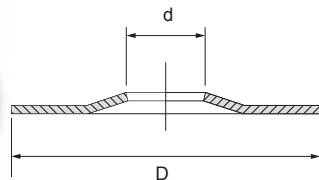

AC N°	Size				Models
	D		d		
	mm	mm	mm	in	
FP-3-1	75	3	22.2	7/8	FG-5PX-1
FP-5-1	125	5	22.2	7/8	

ABRASIVE TOOLS

ACCESSORIES

SANDING DISCS FOR ANGLE AND VERTICAL SANDERS

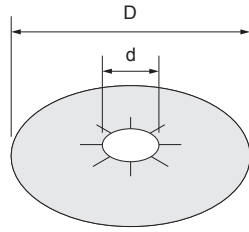

AC N°	Size				Grit #	Models
	D		d			
	mm	in	mm	in		
DP-5**	125	5	22.2	7/8	14-60	FG-5PX-1
DP-6**	150	6	22.2	7/8	14-60	FA-150K-2, 3
DP-7	180	7	22.2	7/8	14-60	FA-6C-9, 9M FA-7E-1, 5 Series, 150KG-7 FV-7-1M, 2M
DP-9	230	9	22.2	7/8	14-50	FA-9C-2

**Minimum order required : 500pcs. / item
*Minimum order required : 100pcs. per item.

BEVEL WIRE BRUSHES

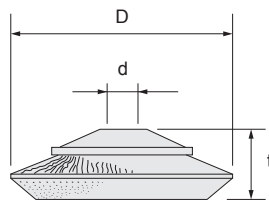

AC N°	Size			Maximum Free Speed	Models
	D	t	d		
	mm	in	mm	mm ⁻¹	
195	125	35	16	8,400	FA-150K-2, 3
195S	125	35	16	8,400	

*S - Stainless Steel
*Minimum order required : 10pcs. / item.

CUP WIRE BRUSHES

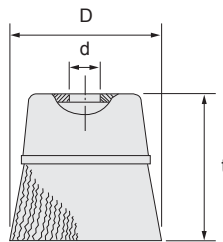

AC N°	Size			Maximum Free Speed	Models
	D	t	d		
	mm	in	mm	mm ⁻¹	
192	75	47	16	8,400	FA-150K-2, 3, 4CHK-3, 3F
193	100	55	16	8,400	FA-150K-2, 3, 4CHK-3, 3F
192S	75	47	16	7,000	FA-6C-9, 10, 9M, 5C-5
193S	100	55	16	7,000	FA-6C-9, 10, 9M, 5C-5
194	120	65	16	6,000	FA-150KG-7

*S - Stainless Steel
*Minimum order required : 10pcs. / item.

DEPRESSED CENTER GRINDING WHEELS

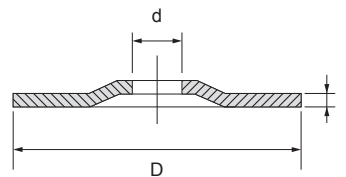

AC N°	Size						Material	Maximum Free Speed	Models
	D		t		d				
	mm	in	mm	in	mm	in	mm ⁻¹		
161	50	2	4	5/32	9.53	3/8	15,000	FA-2C-1, 1BF, 2CX-1, 1BF	
161-1S	50	2	2	5/64	9.53	3/8			
162	75	3	4	5/32	9.53	3/8	15,000	FA-3C-1, 1F, 3CX-1, 1F	
169	125	5	6	1/4	22.00	7/8	12,000	FA-5E-1, 2, 13 Series	
165	180	7	6	1/4	22.00	7/8	8,400	FA-150KG-5, 6C-1, 1M, 6, 6M, 8, 8M, 9, 9M, 12, 12M FA-7E-1, 2, 3, 5, 6, 8 Series, FV-7-1M, 2M, 4M	
168	230	9	6	1/4	22.00	7/8	5,900	FA-9C-2, 2M, 4, 4M, FV-9BH-1M	

*Minimum order required : 25pcs. / item. (162 = Minimum order required : 500pcs. / item, 168 = Minimum order required : 10pcs. / item.)